

Conext™ EasyConfig Tool

Owner's Guide

975-0796-01-01 Revision A
05-2018



Copyright © 2018 Schneider Electric. All Rights Reserved. All trademarks are owned by Schneider Electric Industries SAS or its affiliated companies.

Exclusion for Documentation

UNLESS SPECIFICALLY AGREED TO IN WRITING, SELLER

(A) MAKES NO WARRANTY AS TO THE ACCURACY, SUFFICIENCY OR SUITABILITY OF ANY TECHNICAL OR OTHER INFORMATION PROVIDED IN ITS MANUALS OR OTHER DOCUMENTATION;

(B) ASSUMES NO RESPONSIBILITY OR LIABILITY FOR LOSSES, DAMAGES, COSTS OR EXPENSES, WHETHER SPECIAL, DIRECT, INDIRECT, CONSEQUENTIAL OR INCIDENTAL, WHICH MIGHT ARISE OUT OF THE USE OF SUCH INFORMATION. THE USE OF ANY SUCH INFORMATION WILL BE ENTIRELY AT THE USER'S RISK; AND

(C) REMINDS YOU THAT IF THIS MANUAL IS IN ANY LANGUAGE OTHER THAN ENGLISH, ALTHOUGH STEPS HAVE BEEN TAKEN TO MAINTAIN THE ACCURACY OF THE TRANSLATION, THE ACCURACY CANNOT BE GUARANTEED. APPROVED CONTENT IS CONTAINED WITH THE ENGLISH LANGUAGE VERSION WHICH IS POSTED AT [HTTP://SOLAR.SCHNEIDER-ELECTRIC.COM](http://solar.schneider-electric.com).

Document Number: 975-0796-01-01 **Revision:** Revision A **Date:** 05-2018

Product Part Numbers: PVSCL125A (CL-125A—North American version)
PVSC125E (CL-125E—IEC version)

Contact Information: <http://solar.schneider-electric.com>

Please contact your local Schneider Electric Sales Representative or visit our website at:
<http://solar.schneider-electric.com/tech-support/>

About This Guide

Purpose

The purpose of this Owner's Guide is to provide procedures for installing and using the Conext CL125 EasyConfig Tool for CL PV string inverters only.

Scope

The Guide provides general information about the EasyConfig Tool, as well as information about installing and using the tool to set parameters for the CL PV string inverter. It does not include information on how to use other Schneider Electric products.

Software Version and Download

To view the latest available software version online, go to:

- NA - <https://solar.schneider-electric.com/product/conext-cl-125-a-string-inverter/>, go to **DOWNLOADS** -> **Firmware**
- IEC - <https://solar.schneider-electric.com/product/conext-cl-125-string-inverter/>, go to **DOWNLOADS** -> **Firmware**

Audience

The Guide is intended for use by qualified technicians and engineers who are authorized to set parameters on the CL PV string inverters by using the EasyConfig Tool.

Organization

This Guide is organized into the following four chapters:

Chapter 1, "Introduction"

Chapter 2, "Software Installation"

Chapter 3, "Software Operation"

Chapter 4, "Setting Inverter Parameters and Upgrading the Firmware (RS485)"

Abbreviations and Acronyms

DHCP	Dynamic Host Configuration Protocol
DNS	Domain Name System
EMI	Electromagnetic Interference
LAN / WAN	Local Area Network / Wide Area Network
LED	Light Emitting Diode (used for indicator lights)
POA	Plane of Array
PV	Photovoltaic (or Solar)
TCP/IP	Transmission Control Protocol/Internet Protocol

Related Information

You can find more information about Schneider Electric as well as its products and services at <http://solar.schneider-electric.com>.

Important Safety Instructions

READ AND SAVE THESE INSTRUCTIONS - DO NOT DISCARD

This document contains important safety instructions that must be followed during installation procedures (if applicable). **Read and keep this Owner's Guide for future reference.**

Read these instructions carefully and look at the equipment (if applicable) to become familiar with the device before trying to install, operate, service or maintain it. The following special messages may appear throughout this bulletin or on the equipment to warn of potential hazards or to call attention to information that clarifies or simplifies a procedure.



The addition of either symbol to a "Danger" or "Warning" safety label indicates that an electrical hazard exists which will result in personal injury if the instructions are not followed.



This is the safety alert symbol. It is used to alert you to potential personal injury hazards. Obey all safety messages that follow this symbol to avoid possible injury or death.

DANGER

DANGER indicates an imminently hazardous situation, which, if not avoided, will result in death or serious injury.

WARNING

WARNING indicates a potentially hazardous situation, which, if not avoided, can result in death or serious injury.

CAUTION

CAUTION indicates a potentially hazardous situation, which, if not avoided, can result in moderate or minor injury.

NOTICE

NOTICE indicates important information that you need to read carefully.

Safety Information

1. Before using this software application, read all instructions and cautionary markings on the unit, in the CL125 Owner's Guide, and all appropriate sections of this manual.
2. Use of accessories not recommended or sold by the manufacturer may result in a risk of fire, electric shock, or injury to persons.

⚠ WARNING
HAZARD OF PHYSICAL INJURY AND UNEXPECTED OPERATION Refer to detailed information in this guide when making any changes to settings or sending commands to the unit. Commands sent from this software application may affect other components in the system. Ensure that anyone working with the system is aware of the result of your changes before sending a command. Failure to follow these instructions can result in death or serious injury.

Lock-Out Tag-Out (LOTO) Procedure

Lock-out refers to the practice of preventing de-energized circuits from being re-energized by putting locks on the disconnecting devices, holding them open. Tag-out refers to the practice of attaching a tag to the disconnect-device locks warning others not to operate the disconnect device and containing information relating to the lock-out, such as the person responsible, the reason, and the date and time. Combined these two practices are called the lock-out and tag-out (LOTO) procedure.

⚠️⚠️ DANGER

ELECTRIC SHOCK, EXPLOSION, OR ARC FLASH HAZARDS

- Apply appropriate personal protective equipment (PPE) and follow safe electrical work practices.
- This equipment must only be installed and serviced by qualified electrical personnel.
- Never energize the inverter with the covers removed.
- Always use a properly rated voltage sensing device to confirm all circuits are de-energized.
- Replace all devices and covers before turning on power to this equipment.
- The inverter is energized from multiple sources. Before opening the cover identify the power source, de-energize, lock-out and tag-out, and wait at least ten minutes for circuits to discharge.
-

Failure to follow these instructions will result in death or serious injury.

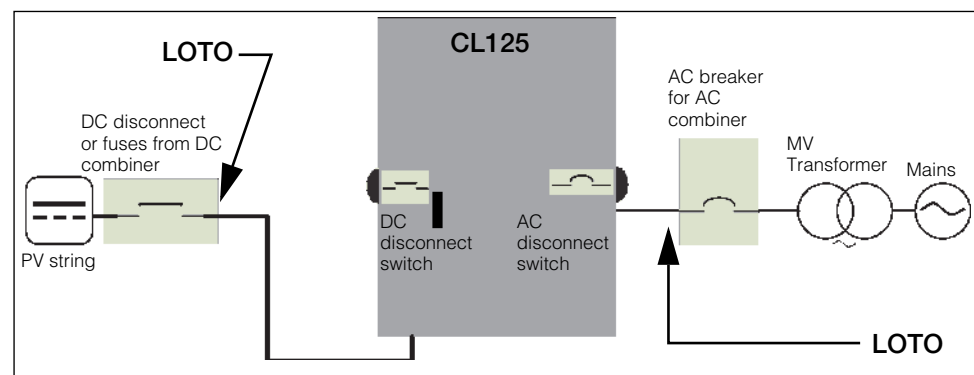

Figure 1-1 Single Line Diagram for CL

1. Identify the external AC disconnect device, such as an AC breaker from the AC Combiner downstream, from the CL125 unit.
2. Open the AC disconnect device that connects to the CL125 to cut off the AC power source.

3. Open the CL125's internal AC disconnect switch by turning the knob to the OFF position.
4. Lock-out and tag-out the external AC disconnect device.
5. Identify any external DC disconnect device from the DC Combiner upstream from the CL125 unit.
6. Open the DC disconnect device (or if a DC disconnect is absent, then disengage the fuseholder) that connects to the CL125 to cut off the DC power source.
7. Lock-out and tag-out the external DC disconnect device.
8. Open the CL125's internal DC disconnect switch by turning the switch lever to the OFF position.
9. Wait at least ten minutes for the circuits in the CL125 to discharge.
10. Check that the inverter is in zero energy state before performing work.
11. Open the CL125 enclosure and commence service and maintenance activities.

Contents

Important Safety Instructions

Safety Information	vi
Lock-Out Tag-Out (LOTO) Procedure	vii

1 Introduction

Introduction	1-2
Features	1-2

2 Software Installation

System Requirements	2-2
Software Installation	2-3

3 Software Operation

Starting the EasyConfig Tool	3-2
Closing the EasyConfig Tool	3-2

4 Setting Inverter Parameters and Upgrading the Firmware (RS485)

Connecting the Serial Adapter	4-2
Logging In	4-3
Search Process	4-4
Searching Devices for the First Time	4-5
Searching Subsequent Times	4-9
Main Window	4-10
Searching for Devices (Inverters)	4-12
Managing Devices	4-16
Deleting all Devices	4-16
Deleting Selected Devices	4-16
Modifying a Device Address	4-17
Viewing Device Information	4-18
Setting Inverter System Parameters	4-19
Setting Running Parameters	4-20
Setting Protection Parameters	4-21
Upgrading the Inverter Firmware	4-23
Upgrading CL125 PV string inverter Firmware	4-23

1

Introduction

Chapter 1 contains general information about Conext CL125 EasyConfig Tool Features.

Introduction

The Conext CL125 EasyConfig Tool is used for firmware upgrade and configuration of CL PV string inverters. The tool facilitates access to single or multiple inverters by using computers to connect over Modbus RS485.

Once the software is installed on a computer, inverters can be configured locally by logging in to the application.

This tool provides single-point access to configuration set up for all the inverters installed in the plant. The tool also provides a means to upgrade firmware on the CL125 inverter when new firmware is available with features and country grid-code compliance.

Features

- Firmware upgrade
- Daisy chain connection over Modbus RS485
- Local monitoring of individual inverters
- Configuration of anti-islanding protection settings and Active-Reactive Power control parameters

2

Software Installation

Chapter 2 contains information about:

- System Requirements
- Software Installation

System Requirements

The Conext CL125 EasyConfig Tool requires the following:

Item	Minimum Requirement	Recommendation
CPU	2 GHz	Dual-core, > 2 GHz
RAM	2 GB	> 2 GB
Hard disk	250 GB	> 250 GB
Display	SVGA/1024 x 768	SVGA/1024 x 768
Operating System	Windows 7/Windows 10	Windows7/Windows 10
Mouse	Windows compatible	Windows compatible
Sound card	Optional	Windows compatible
Serial port	RS485 to USB adapter TCSMCNAM3M002P or equivalent	RS485 to USB adapter TCSMCNAM3M002P or equivalent

Software Installation

To install the Conext CL125 EasyConfig Tool:

1. Double-click the **setup.exe** file in the installation package to run the installation program. The Setup Wizard dialog window opens.

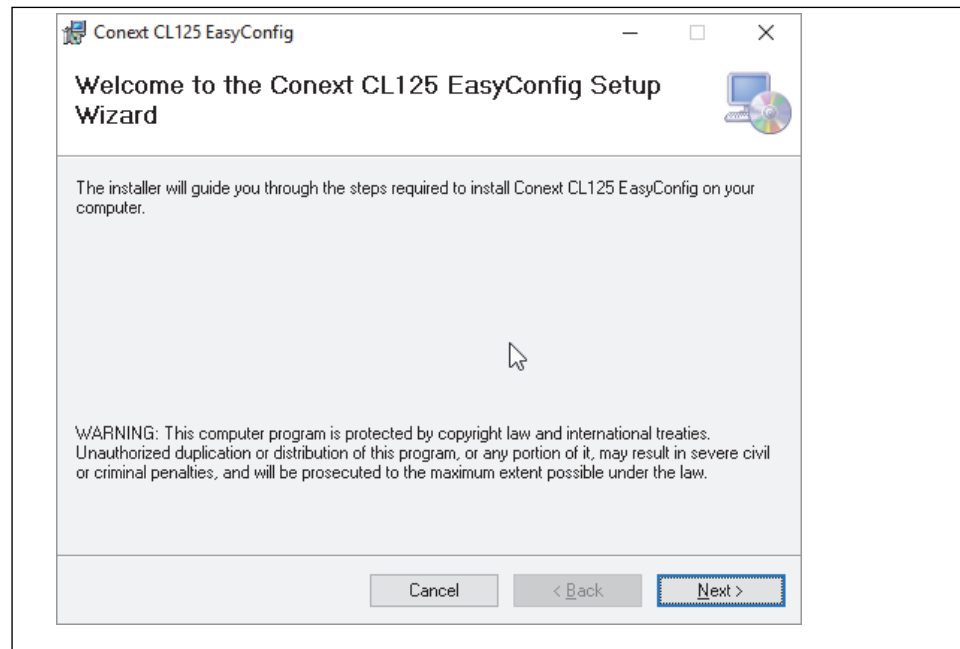

Figure 2-1 Setup Wizard

2. Click the **Next** button to proceed. The Select Installation Folder dialog window opens.

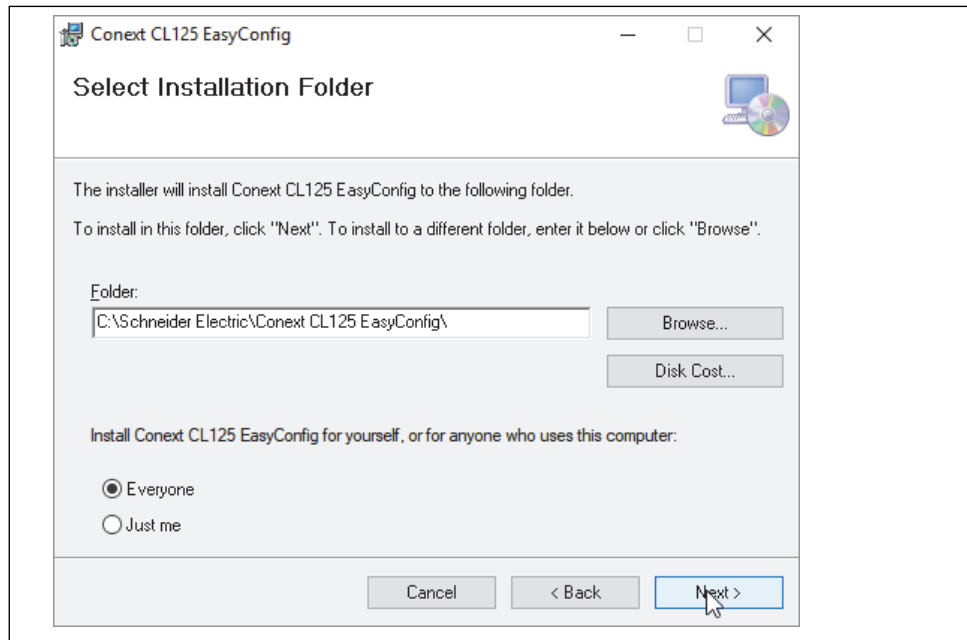

Figure 2-2 Select Installation Folder

3. On the Select Installation Folder page, do the following:
 - (optional) To install to a different location, click the **Browse...** button.
 - (optional) To find out how much disk space is required, click the **Disk Cost...** button.
 - Specify who can access the Conext CL125 EasyConfig Tool installation:
 - To apply the installation across all users of the computer, select **Everyone**.
 - To apply the installation to the current user, select **Just me**.
 - Click the **Next** button to install the Conext CL125 EasyConfig Tool.The **Confirm Installation** dialog window opens.

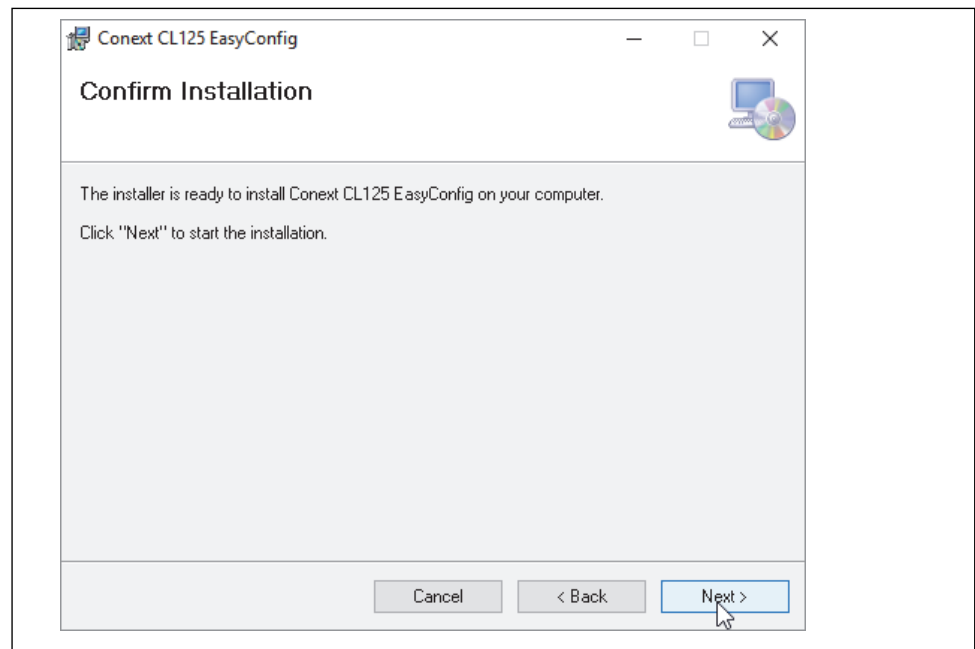

Figure 2-3 Confirm Installation

4. Click the **Next** button to proceed.
The program will be installed on the computer. Monitor the progress bar.



Figure 2-4 Installation Progress

The Installation Complete dialog window appears.

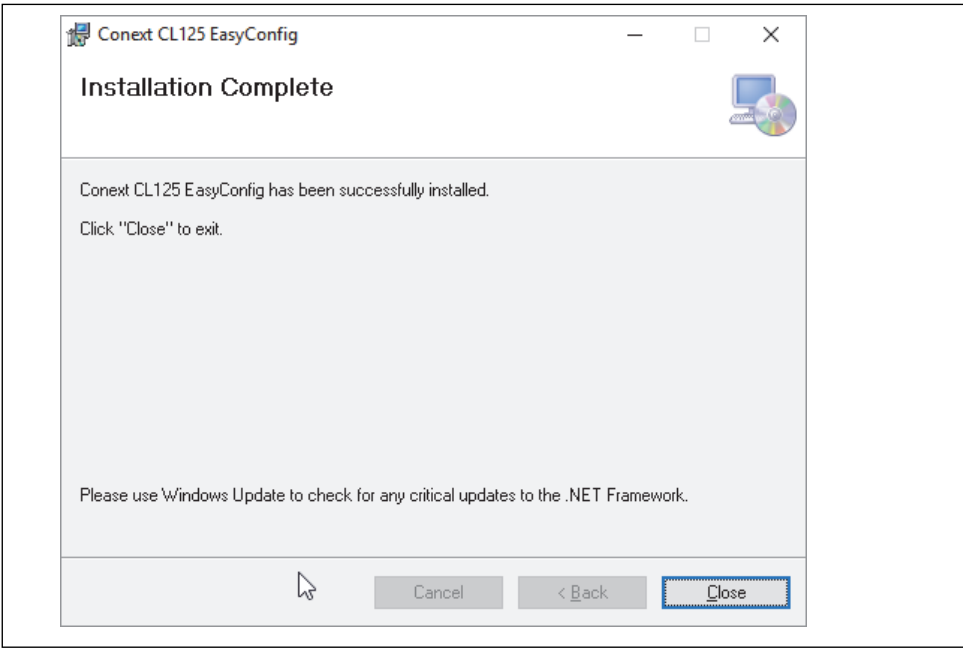

Figure 2-5 Installation Complete

- 5. Click the **Close** button to exit the installation wizard. A shortcut icon for the program will appear on the desktop.



3

Software Operation

Chapter 3 contains information about:

- Starting the EasyConfig Tool
- Closing the EasyConfig Tool

Starting the EasyConfig Tool

To start the EasyConfig Tool, use either method below:

- ◆ Click **Start -> Programs -> Conext CL125 EasyConfig -> Conext CL125 EasyConfig**
- ◆ Double-click the **Conext CL125 EasyConfig Tool** icon on the desktop



Closing the EasyConfig Tool

To close the EasyConfig Tool:

- ◆ Click the  button on the upper right corner of any window.

4

Setting Inverter Parameters and Upgrading the Firmware (RS485)

Chapter 4 contains information about:

- Connecting the Serial Adapter
- Logging In
- Search Process
- Main Window
- Searching for Devices (Inverters)
- Managing Devices
- Viewing Device Information
- Setting Inverter System Parameters
- Setting Running Parameters
- Setting Protection Parameters
- Upgrading the Inverter Firmware

Connecting the Serial Adapter

To connect the serial adapter:

1. Ensure the inverter is completely de-energized.
2. Connect the serial adapter as described in the “Communication Connection” section of the *Conext CL 125 Owner’s Guide*.

TIP: Plug the serial adapter to the **RS485_2 (Modbus port 2)** connector on the communication circuit board of the inverter.

3. Ensure there are no PLC, monitoring gateways, or other Modbus master devices in the Modbus network.
4. Replace the cover on the inverter.
5. Energize the inverter by applying DC power.
6. Determine the COM port of the adapter through Windows Device Manager.

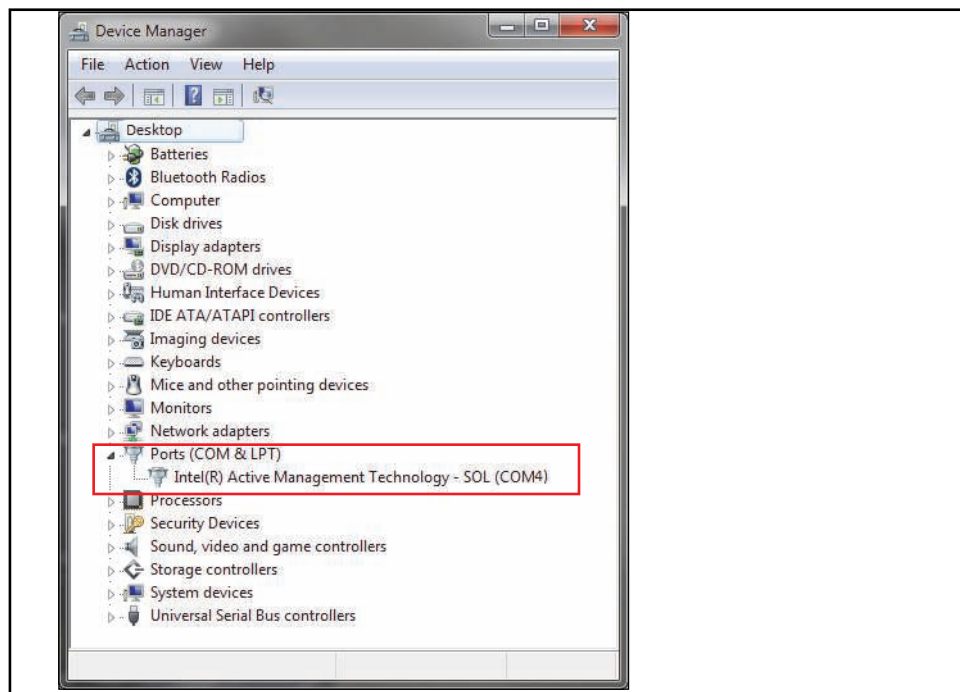

Figure 4-1 Device Manager window showing the available COM ports

Logging In

After starting the EasyConfig Tool successfully, the **Login** window appears.

To log in:

1. Select the **Access mode: COM** (default) or **Ethernet**.
2. Enter the Level 1 **Password: 111111**.
For the Level 2 password, contact your Sales Application Engineer.
3. Select the preferred **Language: English** (default).
4. Click the **Login** button.



Figure 4-2 EasyConfig Tool Login Window

Search Process

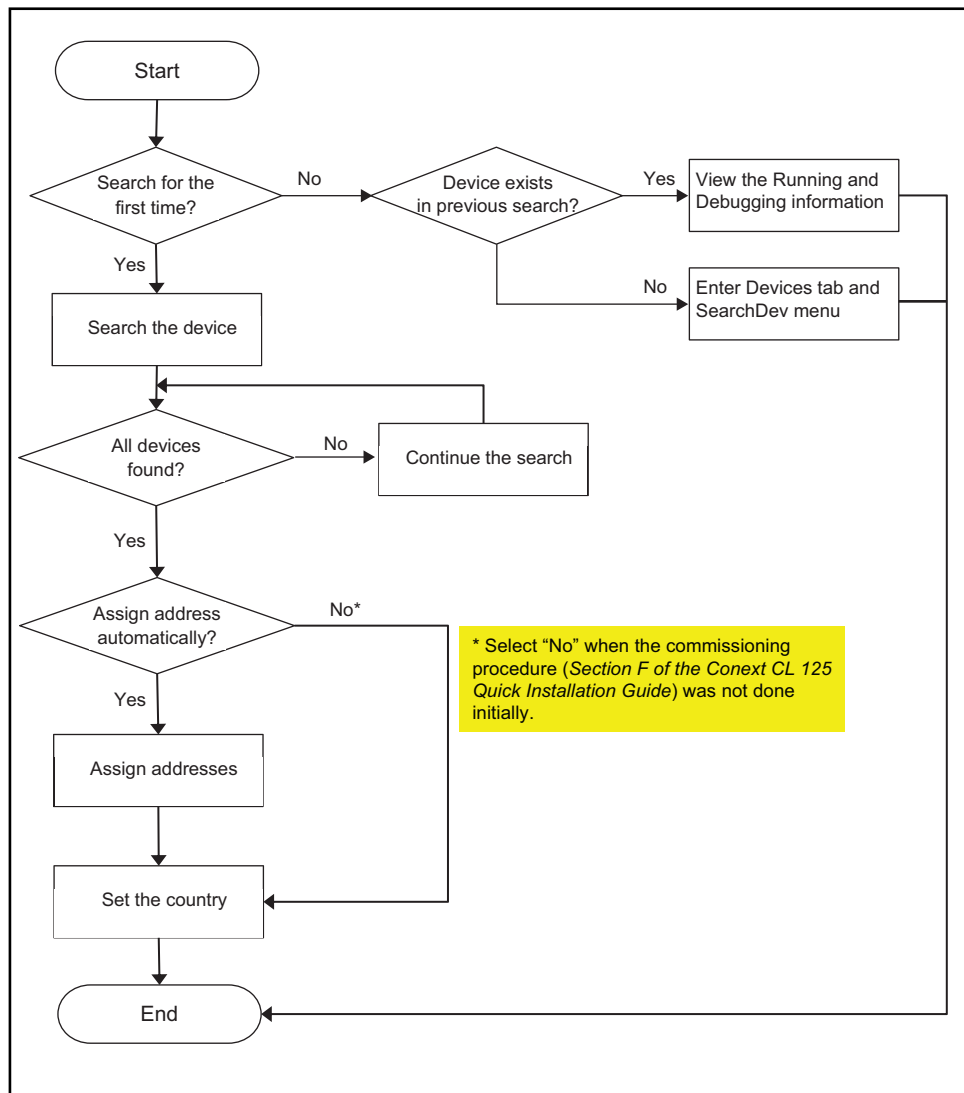

Figure 4-3 Search Process

Searching Devices for the First Time

The first time you search for devices, the EasyConfig Tool does not check for previous connections. However, once you have completed the first search and the devices are available, the EasyConfig Tool, subsequently displays the result from previous searches under ViewInfo.

To search for a device for the first time:

1. Log in to the EasyConfig Tool. See *“Logging In” on page 4-3*.
After a successful log in, the following dialog window appears.

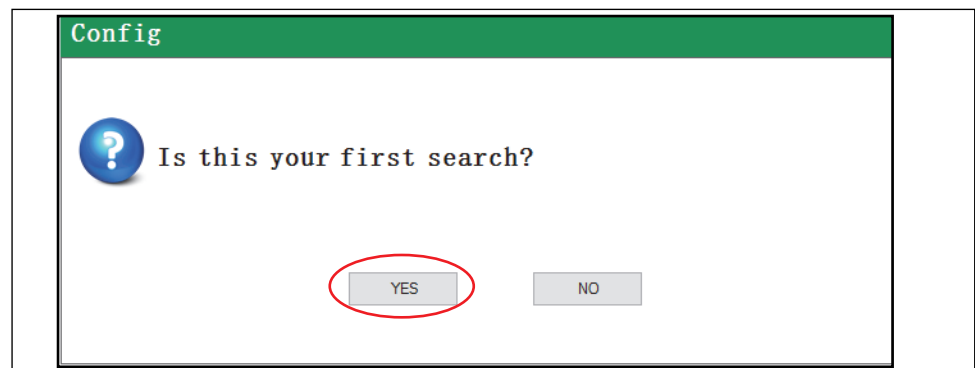

2. Click the **YES** button.
The EasyConfig Tool displays the Search window.

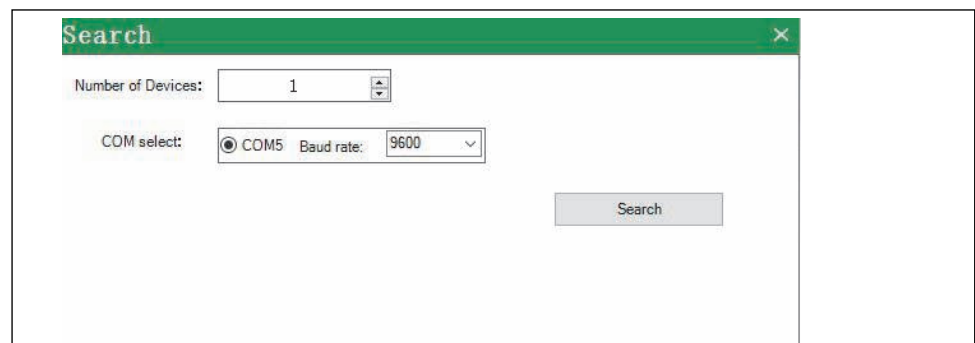

Figure 4-4 Search Window

3. In the Device Number field, enter the number of devices and, under COM select, select the COM port/ baud rate that you want to search for. Then, click the **Search** button.

NOTE: To determine which COM port to select, check **Device Manager > Ports (COM & LPT)**. See *“Connecting the Serial Adapter” on page 4-2*.
A summary window shows the devices found.

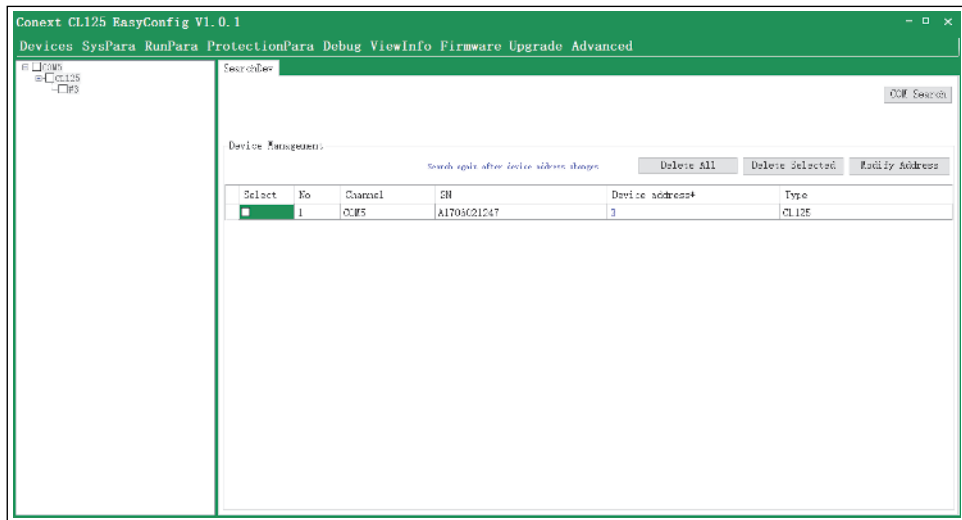
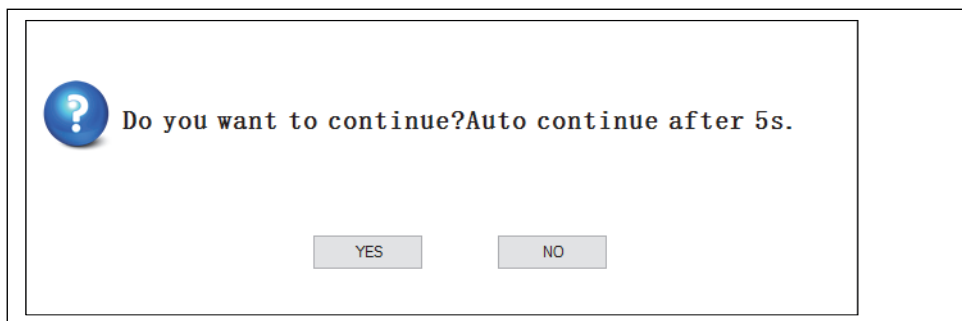

Figure 4-5 Devices Summary Window

4. If the search times out before the number of devices specified for the search are found, the following dialog window appears.



- To stop the search, click the **NO** button.
- To continue searching immediately, click the **YES** button.

If you do not click a button in the dialog, after five seconds, the EasyConfig Tool continues searching. This step repeats until all the devices are found or you click the **NO** button.

5. When all devices are found or you click the **NO** button at the previous step, the following dialog window appears.

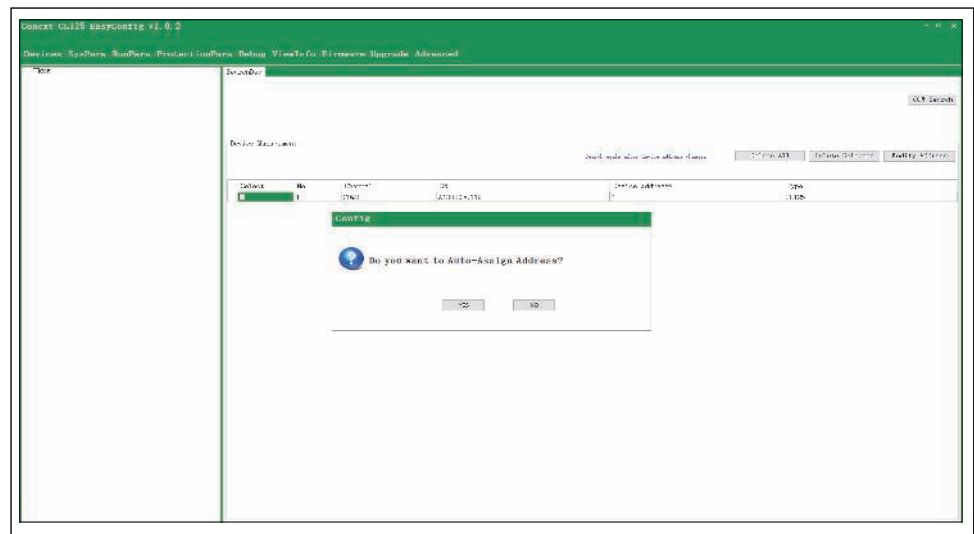

Verify if the Commissioning procedure (*Section F of the CL-125 Quick Install Guide*) was performed before proceeding to the next step.

6. In the dialog window, do one of the following:
- If the Commissioning procedure was not done, click the **NO** button. Proceed to Step 7 without assigning Modbus addresses.
 - Click the **YES** button to automatically assign the device addresses. The **Auto Assigned Address Settings** window (Figure 4-6) appears. Click the **OK** button. A **Change Completed** dialog window appears. In the dialog window, click the **Confirm** button.

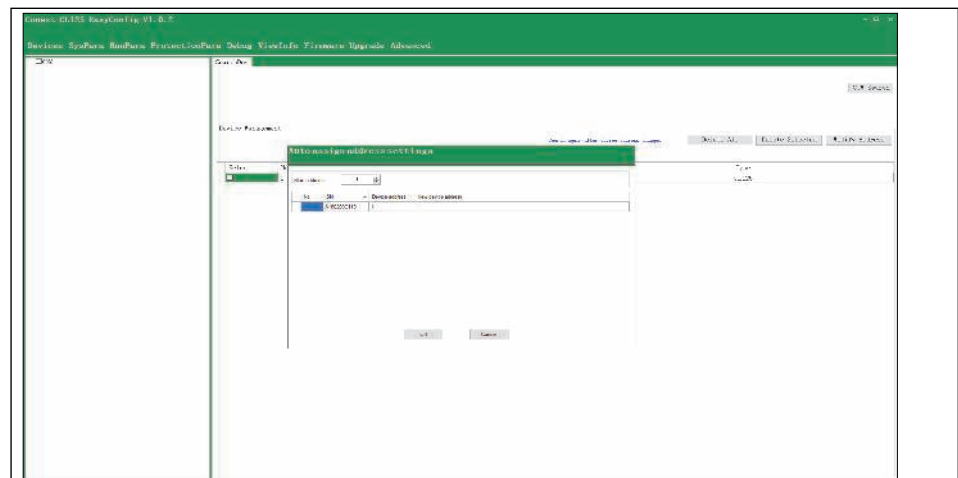
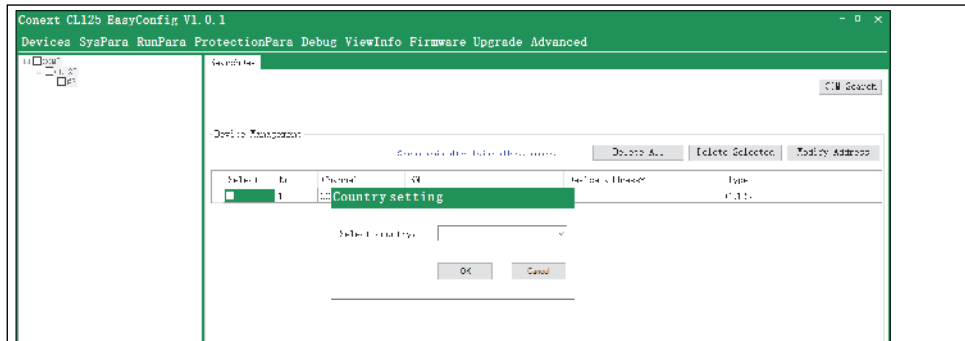

Figure 4-6 Auto assigned address settings window

7. On the **Country setting** window, select the country and click the **OK** button.



NOTE: The **Select a Country** drop-down lists includes France, India, US_Rule_21 (or US), and Others. Set the Country according to the jurisdiction where the inverter is installed.

8. If you changed the country setting, restart the CL125 PV string inverter by power cycling the DC and AC power.

Searching Subsequent Times

If you have previously searched for devices, the EasyConfig Tool does not show the history of connections and it automatically displays the **Devices** window. If you are searching for the first time, see “*Searching Devices for the First Time*” on page 4–5.

To search for a device:

After a successful log in, the following dialog window appears.

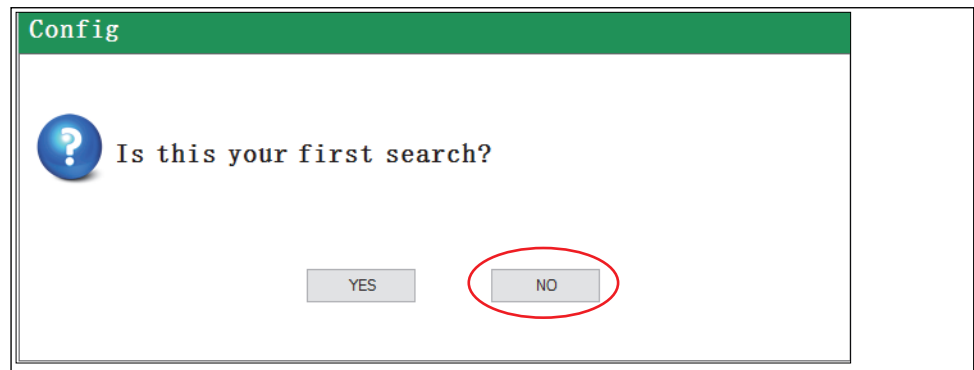

- ◆ Click the **NO** button.

The **Devices** window opens. By default, the **SearchDev** tab will be shown. See the section “*Searching for Devices (Inverters)*” on page 4–12 to perform a subsequent search and to detect devices manually.

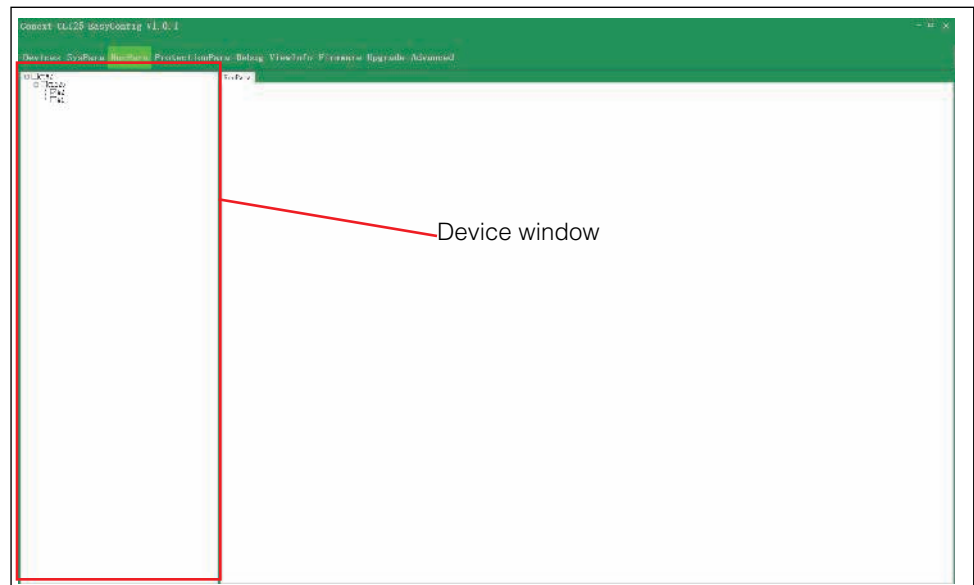

Figure 4-7 Devices Window

Main Window

The EasyConfig Tool's main window is divided into different sections as shown in Figure 4-8.

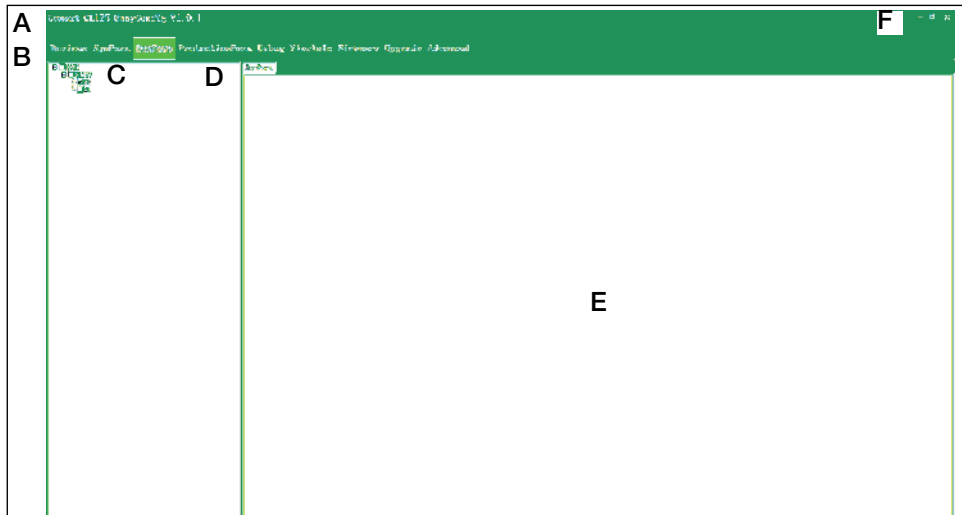

Figure 4-8 EasyConfig Tool Main Window

Label	Description	Remarks
A	Title Bar	Name of the software and software version information.
B	Navigation Bar	<p>Devices: Search the device.</p> <p>SystemPara: Set up and read the system parameters of the device.</p> <p>RunPara: Set up and read the parameters, including active/reactive power regulation, run time, LVRT, and frequency derating, etc.</p> <p>ProtectionPara: Set up and read the protection parameters.</p> <p>Debug: Send and receive and display the debug message that is sent manually.</p> <p>ViewInfo: Dynamically display the operation information of a single device.</p> <p>FirmwareUpgrade: Upgrade the inverter firmware for a single device or for multiple devices.</p>

Label	Description	Remarks
C	Device Tree	Displays all devices found in the PV system. The tree shows how the devices are interconnected.
D	Menu Bar	Displays the selected tab from the Navigation bar. In some cases, a sub-menu will appear below the Menu bar tab with additional tabs.
E	Settings	Displays the current parameters associated with the selected tab for the selected device.
F	Basic Tools	Buttons for minimizing, maximizing, and closing the window.

Searching for Devices (Inverters)

NOTE: When you search the devices with COM Search, check that all the Modbus addresses on the inverter are valid and unique.

To search the devices:

1. Click the **SearchDev** tab and select the serial port (for example, **COM**).

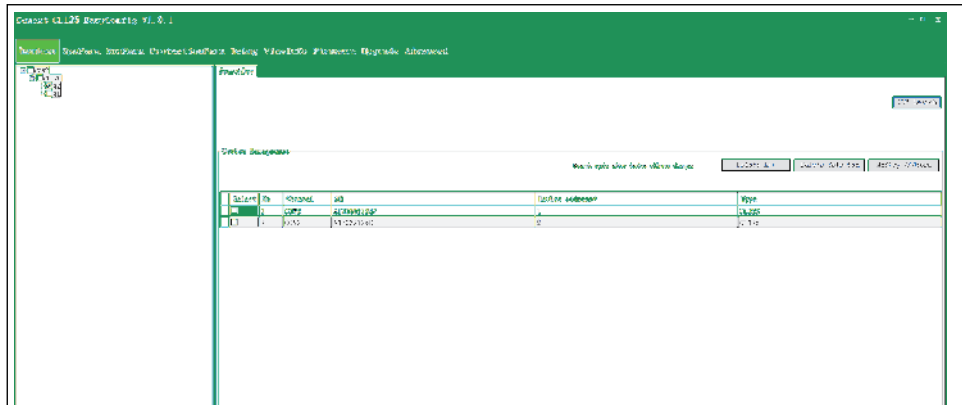
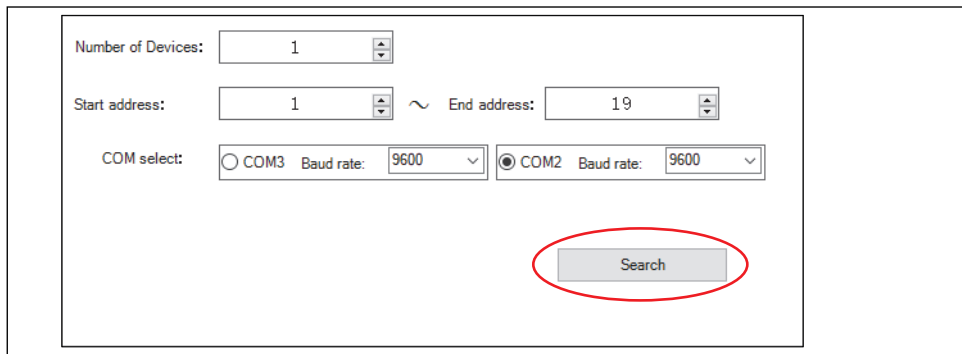

Figure 4-9 Devices Tab

2. Click the **COM Search** button at the upper-right corner of the window. The **Search** window appears.



- Select a **Device number** (number of devices to search)
- Specify a range of **Start** and **End addresses**
- Specify the **Baud rate**
- Click the **Search** button

Note: " Comm port parameters can also be configured using the eConfigure CL125 APP. Please refer to the Owner's Guide for more details

The EasyConfig Tool starts to search for the devices.

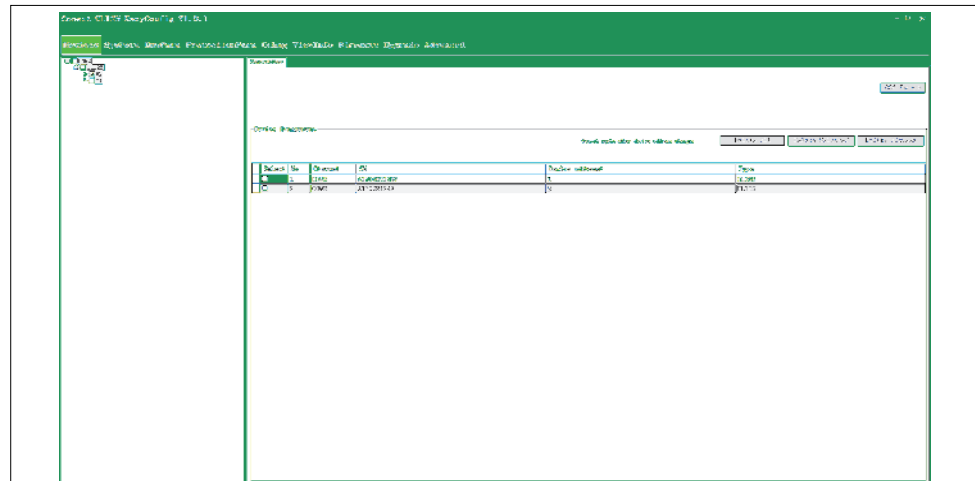

3. If the search times out before the number of devices specified are found, the following dialog window appears.

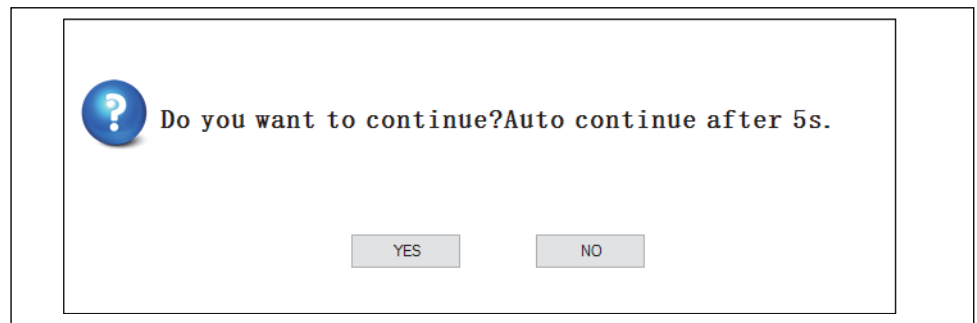

- To stop the search, click the **NO** button.
- To continue searching immediately, click the **YES** button. If you do not click either button, after five seconds, the search automatically continues. This step repeats until all the devices are found or you click the **NO** button on the dialog window.

4. The following dialog window appears after the search is completed.

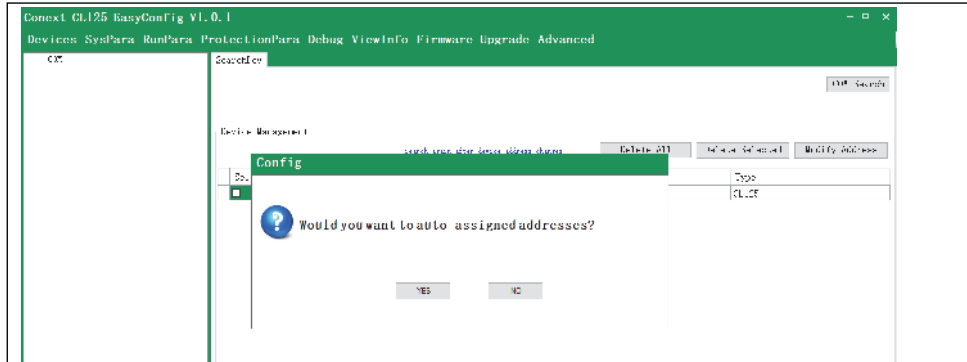

Figure 4-10 Auto Assigned Address Dialog Box

- Click the **YES** button to display the Auto assigned address settings summary window.
- The EasyConfig Tool will automatically display the inverters searched starting with the smallest serial number to the largest.

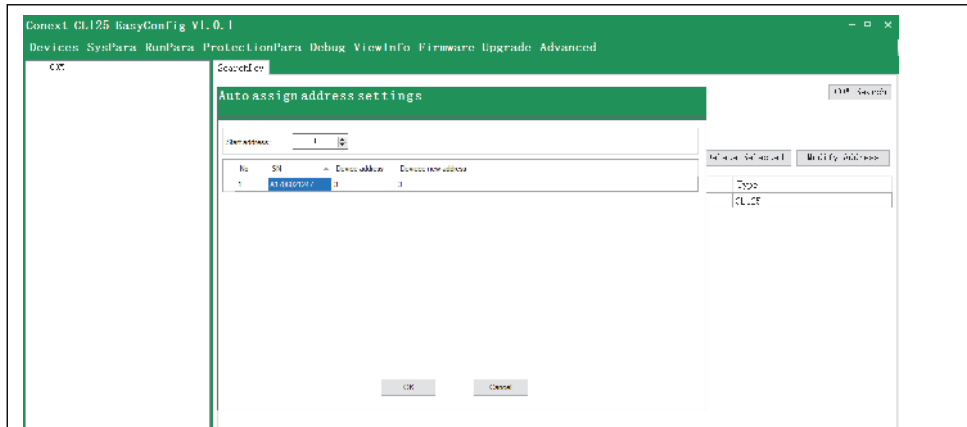

Figure 4-11 Auto assigned address settings window

- Click the **No** button (Figure 4-10) to display the Country setting window.

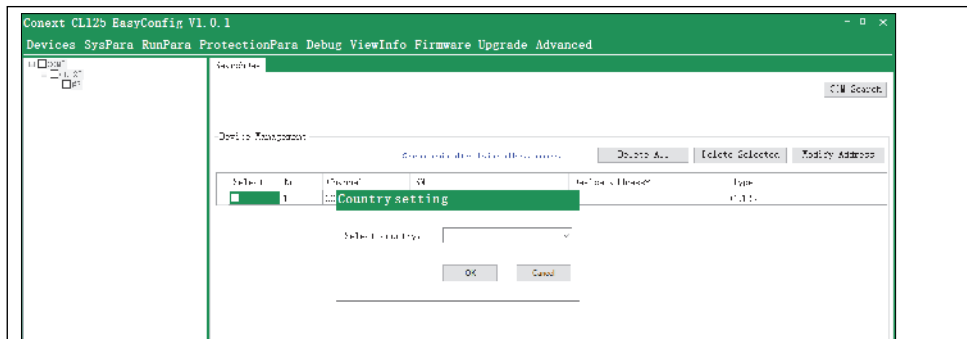

Figure 4-12 Country Setting

- On the **Country setting** window, select the country and click the **OK** button. **NOTE:** The **Select a Country** drop-down lists includes France, India, Canada, America, and Others.
Set the Country according to the jurisdiction where the inverter is installed.
5. Restart the device (inverter) after the setting is completed.

Managing Devices

The **Devices** window allows you to:

- Delete all devices
- Delete selected devices
- Modify the device address

Deleting all Devices

NOTE: If devices are deleted, the devices and their corresponding information will no longer be displayed on the window.

To delete all the devices:

- ◆ Click the **Delete All** button.

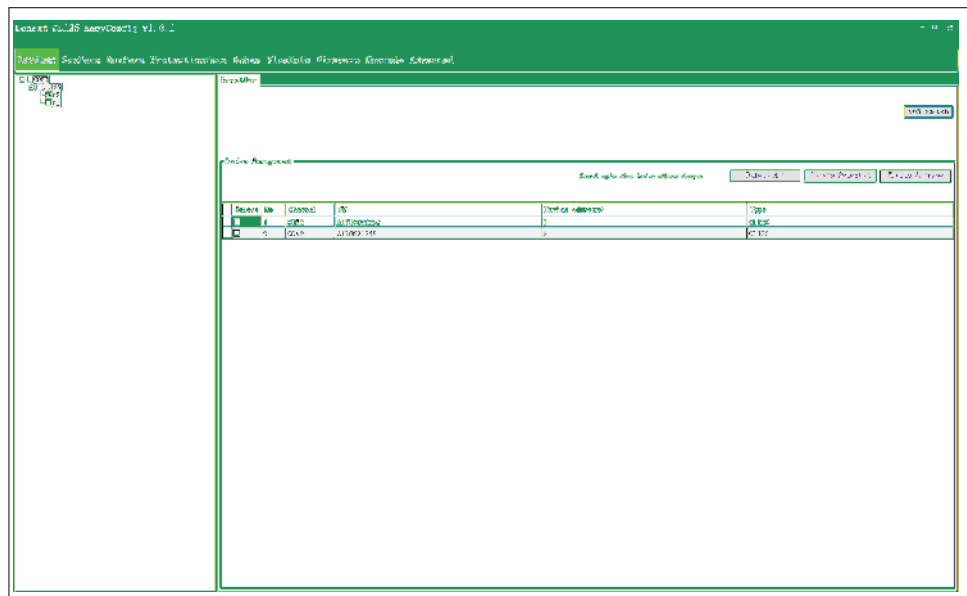

Figure 4-13 Devices Window – Delete All

Deleting Selected Devices

NOTE: If devices are deleted, the devices and their corresponding information will no longer be displayed on the window.

To delete selected devices:

1. In the **Select** column, select the device/s that are to be deleted.
2. Click the **Delete selected** button.

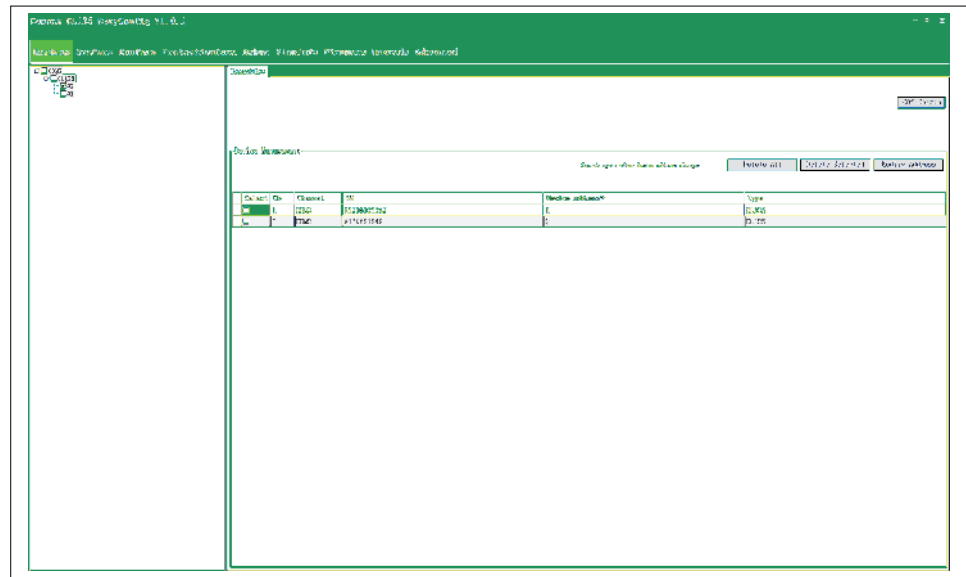

Figure 4-14 Devices Window – Delete Selected

Modifying a Device Address

To modify a device address:

1. In the **Select** column, select the device that is to be modified.
2. Change the device address under the **Device address*** column and click the **Modify Address** button.

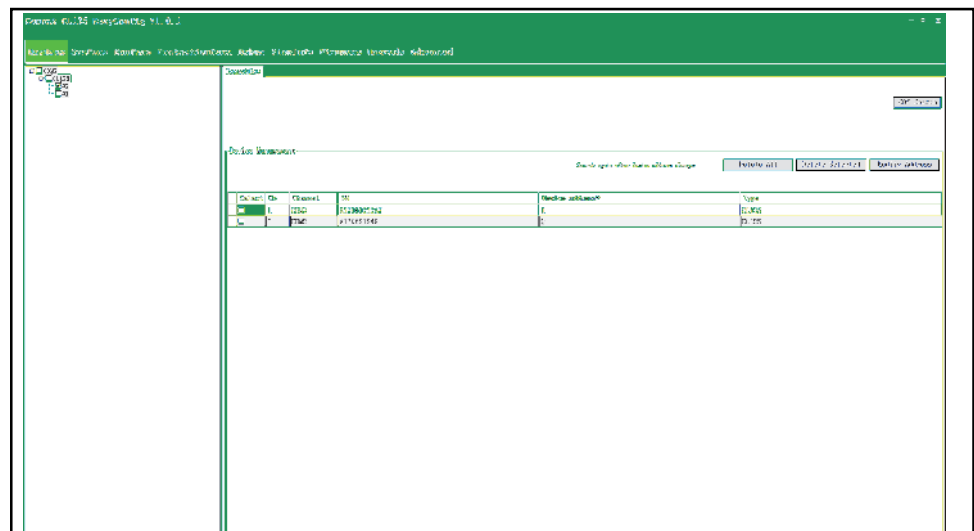

Figure 4-15 Devices Window – Address Modify

3. The pop up message will display while changing the device address. Click the **OK** button and confirm that the tool shows the “Change completed” message.

Viewing Device Information

All the devices that have been found will be displayed in a tree hierarchy in the Device tree in the left panel.

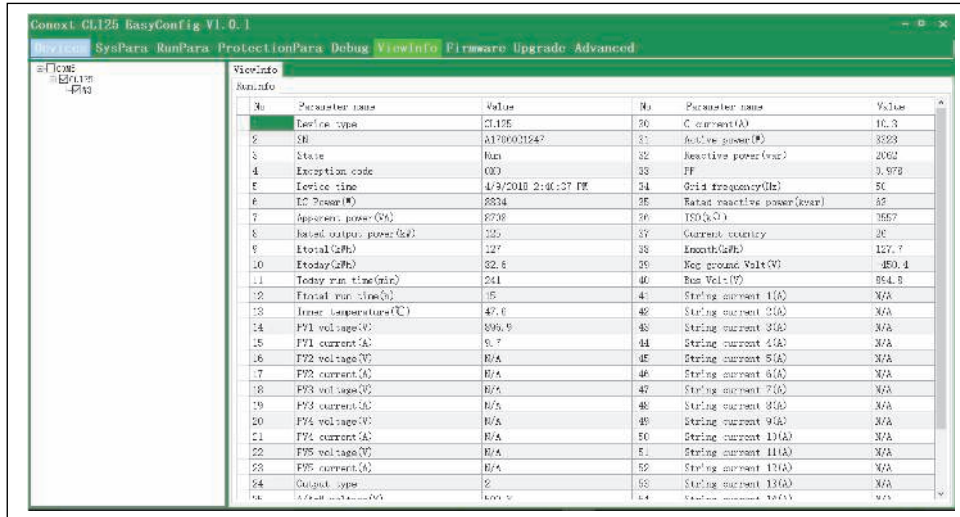

Figure 4-16 EasyConfig Tool Devices Overview Page

If no information is displayed for a device, check that the serial port type has been selected.

To view information for a device:

1. In the Device tree, click a device.
2. In the Menu bar, select one of the following options:
 - To view the running parameters, select **RunPara**
 - To view the device parameters, select **ViewInfo**.

Setting Inverter System Parameters

You must select one device on this interface. No values of parameters are displayed (in a few places) when the Parameters are in OFF condition. For example, when Island judgment criteria is in OFF condition then Frequency Changes values are not editable. When the window appears, the first device is selected by default. You can select other devices manually as required.

To set system parameters:

1. Select any device in the Device tree.

The system parameters will be displayed in the Settings section of the window.

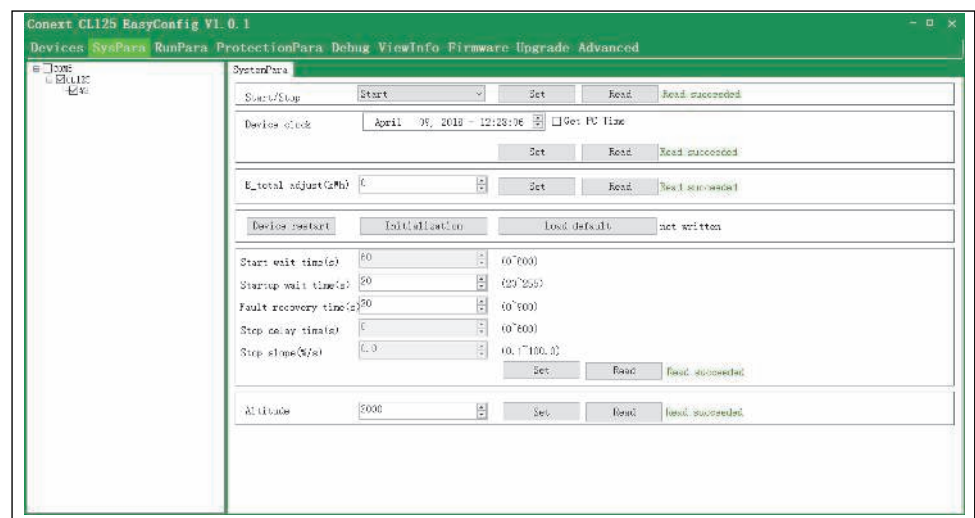

Figure 4-17 EasyConfig Tool Devices Overview Page

2. Set the parameter and click the **Set** button to confirm the setting.
 - To view the old parameter, click the **Read** button.
 - Compare the new parameter with the old to make sure that the new one is valid.

NOTE:

- Parameters are set individually using the **Set** and **Read** buttons that correspond to the specific parameter.
- If more than one device is selected in the Device tree, the **Read** buttons for all parameters are disabled.

Setting Running Parameters

The running parameters include active/ reactive power regulation, run time, LVRT, and frequency derating, etc.

To set the corresponding parameters

1. In the Navigation bar, click **RunPara**.
2. In the Device tree, select one or more devices.
The default values for the parameters will be displayed in the Settings section.
3. On the Menu bar, click one of the following options:
 - **Active Regulation**
 - **Reactive Regulation**
 - **Run Time**
 - **LVRT**
 - **Frequency Derating**
4. To make a parameter configurable, click the **On** button.
 - To view the old value for the parameter, click the **Read** button
 - To save the setting, click the **Set** button.

NOTE: These settings require Level 2 access level.

NOTE: The screen shot shown below is just an example of one country setting. This can vary from one country to another.

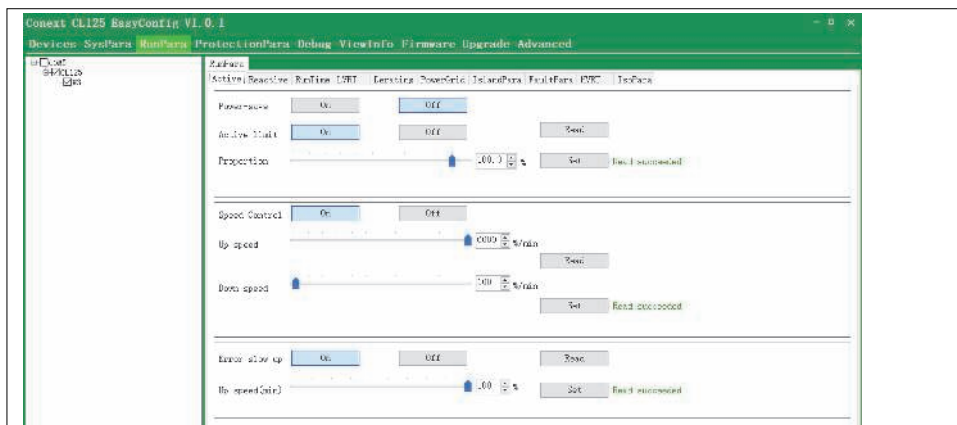

Figure 4-18 Running Parameters

NOTE:

- Parameters are set individually using the **Set** and **Read** buttons that correspond to the specific parameter.
- If more than one device is selected in the Device tree, the **Read** buttons for all parameters are disabled.
- A level 2 password is required to view this information. Contact your Sales Application Engineer.

Setting Protection Parameters

The **Protection Parameters** window allows you to set the country, protection stage, and the corresponding protection parameters.

To set the Protection Parameters:

1. In the Navigation bar, click **ProtectPara**. The Protection Parameters window appears. If the selected country supports multiple grid types, the grid types will be shown below the country setting (Figure 4-20).

NOTE: These settings require Level 2 access level.

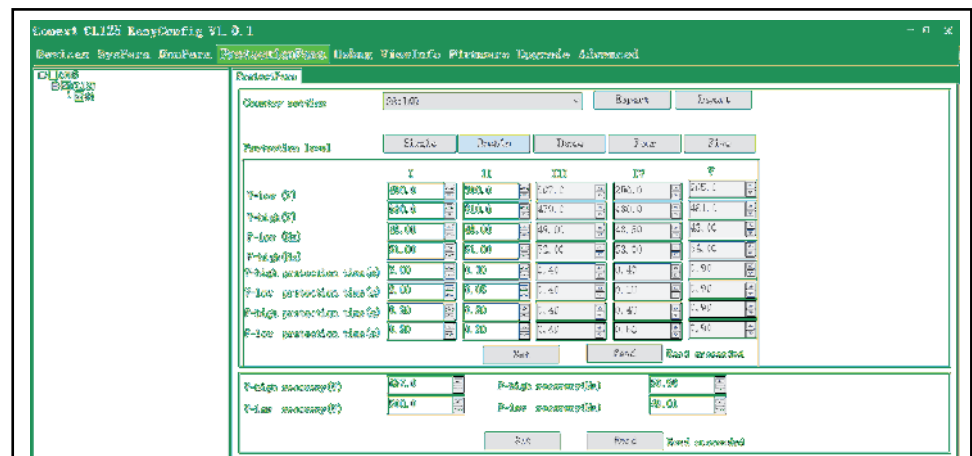

Figure 4-19 Protection Parameters Window - with multiple grid types (LV and MV - for Point of connection at MV)

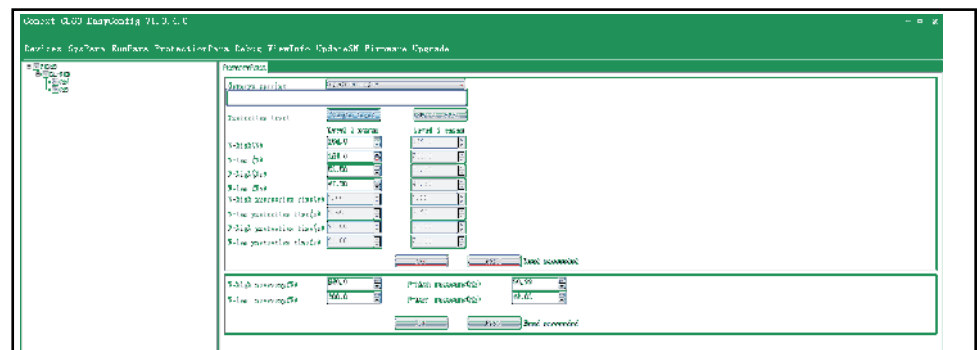

Figure 4-20 Protection Parameters Window - without multiple grid types protection settings

2. On the Protection Parameters window, select the following options:
 - **Country setting:** Select the corresponding country where the device is located.
 - **Grid Type:** Only available for some countries. (Appears by default based on the country grid settings within the Firmware)
 - **Protection level:** Single level or multi level.
3. To view the parameter settings, click the **Read** button.

Optional step

4. Check and confirm the parameters, then click the **Set** button. The settings will be issued to the corresponding device.
5. Follow the message that is displayed for each of the parameters when they are changed.
For example: After a setting the country, the program displays the message **“The country is modified. Please restart the inverter.”**
6. When changing the country for a group of inverters, select all the affected inverters on the left panel of the window, then select the country on the right panel, and click the **Set** button.
7. Restart the inverter(s) and confirm the country setting visually for each inverter.

Upgrading the Inverter Firmware

1. Perform the Lock-Out Tag-Out (LOTO) Procedure. See “*Lock-Out Tag-Out (LOTO) Procedure*” on page vii.
2. Perform the Upgrading CL125 PV string inverter Firmware procedure.

Upgrading CL125 PV string inverter Firmware

You can use the CL125 EasyConfig Tool to upgrade the CL125 PV string inverter firmware.

NOTE: Before beginning this process, make sure you have the correct and latest LCD and DSP firmware files from the <http://solar.schneider-electric.com> website and read the firmware upgrade process associated with the firmware files.

To upgrade the inverter firmware:

1. Install the CL125 EasyConfig Tool. See “*Software Installation*” on page 2–1.
2. Run the CL125 EasyConfig Tool and Search for Inverters. See “*Searching for Devices (Inverters)*” on page 4–12.
3. Upgrade the Inverter Firmware.
 - a. Select the inverters that need a firmware upgrade from the Device tree on the left panel.
 - b. In the CL125 EasyConfig Tool’s main window, click the **Upgrade** tab.

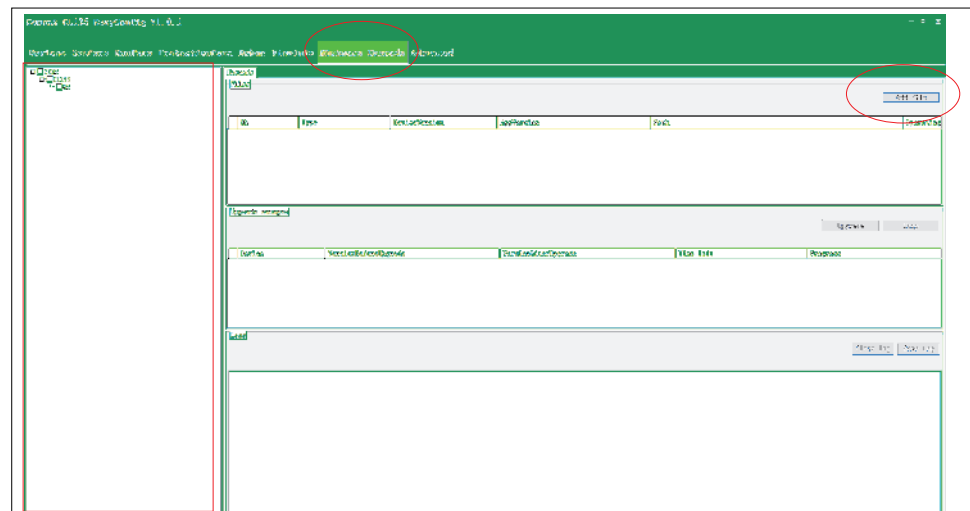

- c. In the top right of the **Settings** window, click the **Add File** button.
 - Use both LCD and DSP firmware files with an **.sgu** extension and select one file at a time for the upgrade.

Setting Inverter Parameters and Upgrading the Firmware (RS485)

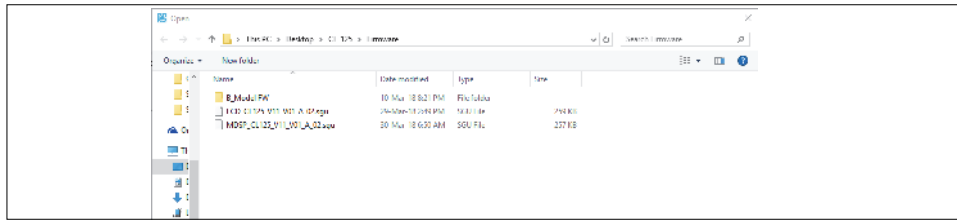

- d. In the **Directory** window, navigate to the folder on your computer where the firmware files are stored.
- Make sure you have the correct and latest LCD and DSP firmware files from the website (<http://solar.schneider-electric.com>) and have read the firmware upgrade process associated with the firmware files.
 - Use both LCD and DSP firmware files with an **.sgu** extension and select one file at a time for the upgrade.

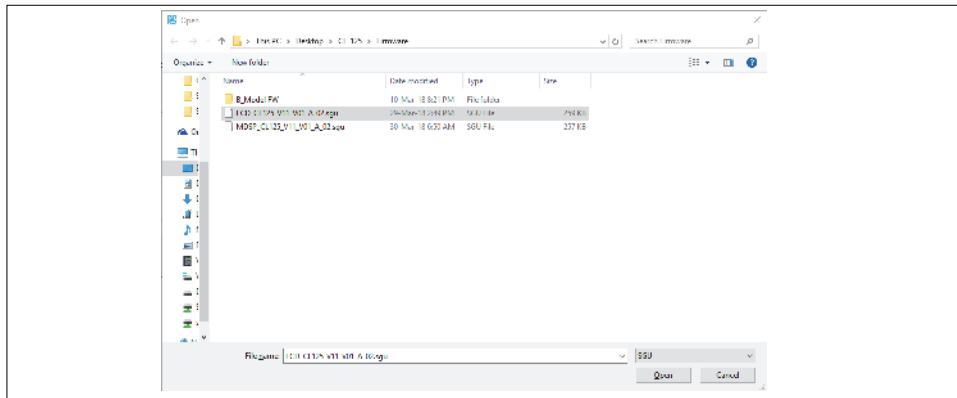

- e. Select the **LCD firmware** file and insert it in the **Files Manage** view. If you need to delete an incorrect file, click the **Delete** button in the Operating column next to the file.
- f. Click the **Upgrade** button and monitor the progress of the firmware upgrade. The upgrade should take 15-20 minutes or less. The Upgrade manager section shows the **Version before upgrade**, **Version after upgrade**, **Time left**, and **Progress bar** for each device being upgraded.
- g. Confirm that the firmware upgrade was successful by verifying that the **Version after upgrade** is a later version than the **Version before upgrade**.
- h. Repeat the same sub-steps (3c through 3g) for the **DSP firmware** file and monitor the progress of the firmware upgrade.
- i. Once the firmware upgrade is successful on your CL125 PV string inverter(s), disconnect the communication cables and restart the inverter(s).
- j. Using the CL125 APP, verify the firmware version(s).

Schneider Electric

<http://solar.schneider-electric.com>

As standards, specifications, and designs change from time to time, please ask for confirmation of the information given in this publication.

© 2018 Schneider Electric. All rights reserved.

975-0796-01-01 Revision A

Printed in: