

Conext CL-60 Inverter Firmware Upgrade Process

976-0380-01-01/B
August 2017
Application Note

EXCLUSION FOR DOCUMENTATION
UNLESS SPECIFICALLY AGREED TO IN WRITING, SELLER
(A) MAKES NO WARRANTY AS TO THE ACCURACY, SUFFICIENCY OR SUITABILITY OF ANY TECHNICAL OR OTHER INFORMATION PROVIDED IN ITS MANUALS OR OTHER DOCUMENTATION; (B) ASSUMES NO RESPONSIBILITY OR LIABILITY FOR LOSSES, DAMAGES, COSTS OR EXPENSES, WHETHER SPECIAL, DIRECT, INDIRECT, CONSEQUENTIAL OR INCIDENTAL, WHICH MIGHT ARISE OUT OF THE USE OF SUCH INFORMATION. THE USE OF ANY SUCH INFORMATION WILL BE ENTIRELY AT THE USER'S RISK; AND (C) REMINDS YOU THAT IF THIS MANUAL IS IN ANY LANGUAGE OTHER THAN ENGLISH, ALTHOUGH STEPS HAVE BEEN TAKEN TO MAINTAIN THE ACCURACY OF THE TRANSLATION, THE ACCURACY CANNOT BE GUARANTEED. APPROVED CONTENT IS CONTAINED WITH THE ENGLISH LANGUAGE VERSION.

Objective

The goal of this application note is to explain how to upgrade the firmware on CL-60 Inverter.

Lock-Out Tag-Out (LOTO) Procedure

Lock-out refers to the practice of preventing de-energized circuits from being re-energized by putting locks on the disconnecting devices, holding them open. Tag-out refers to the practice of attaching a tag to the disconnect-device locks warning others not to operate the disconnect device and containing information relating to the lock-out, such as the person responsible, the reason, and the date and time. Combined these two practices are called the lock-out and tag-out (LOTO) procedure.

DANGER

ELECTRIC SHOCK, EXPLOSION, OR ARC FLASH HAZARDS

- Apply appropriate personal protective equipment (PPE) and follow safe electrical work practices.
- This equipment must only be installed and serviced by qualified electrical personnel. Access to live parts shall be limited to suitably qualified electrical personnel. See installation instructions before connecting to the supply.
- Never operate energized with covers removed.
- Always use a properly rated voltage sensing device to confirm all circuits are de-energized.
- Replace all devices, doors, and covers, before turning on power to this equipment.
- Before opening the cover identify the power source (see **A**), de-energize (see **B**), lock-out and tag-out (see **C**), and wait 10 minutes for circuits to discharge (see **D**).

Failure to follow these instructions will result in death or serious injury.

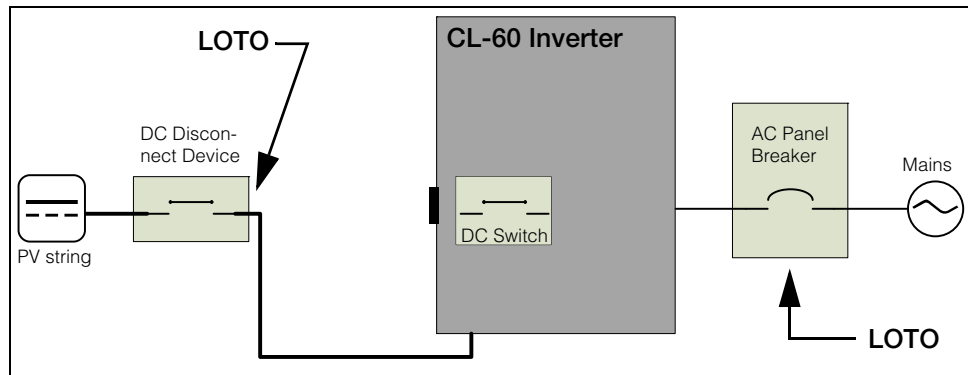

Figure 1 Single Line Diagram for CL-60 Inverter

- A** 1. Identify any disconnect device upstream from the CL-60 Inverter unit.
- B** 2. Open the disconnect device that connects to the CL-60 Inverter to cut off DC power.
- C** 3. Turn the CL-60 Inverter's DC Switch to OFF position.
4. Lock-out and tag out the external DC disconnect device.
5. Remove all PV string connectors from the DC terminals.
- A** 6. Identify the AC Panel Breaker downstream from the CL-60 Inverter unit.
- B** 7. Open the AC Panel door.
8. Turn Off the AC Panel Breaker (open the switch) that connects to the CL-60 Inverter to cut off AC power.
9. Close the AC Panel door.
- C** 10. Lock-out and tag out the AC Panel.
- D** 11. Wait 10 minutes for the circuits in the CL-60 Inverter to discharge.
12. Check that the inverter is in zero energy state before performing work.
13. Open the CL-60 Inverter enclosure and commence service and maintenance activities.

Upgrading CL-60 Inverter Firmware

You can use the Conext CL-60 Easy Config Tool to upgrade the CL-60 Inverter firmware.

DANGER

RISK OF FIRE, ELECTRIC SHOCK, EXPLOSION, AND ARC FLASH

This Application Note is in addition to, and incorporates by reference, the relevant product manuals for each Conext CL-60 Inverter product. Before reviewing this Application Note you must read the relevant product manuals. Unless specified, information on safety, specifications, installation, and operation is as shown in the primary documentation received with the product. Ensure you are familiar with that information before proceeding.

Failure to follow these instructions will result in death or serious injury.

NOTE: Before beginning this process, make sure you have the correct and latest LCD and DSP firmware files from the <http://solar.schneider-electric.com> website and have read the firmware upgrade process associated with the firmware files.

Step 1: Install the Conext CL-60 Easy Config Tool

1. Download the Conext CL-60 Easy Config Tool from the <http://solar.schneider-electric.com> website.
2. Read the *Conext CL-60 Easy Config Tool Owner's Guide* and install the tool on your computer.

Step 2: Run the Conext CL-60 Easy Config Tool and Search for Inverters

1. Connect your inverter(s) to the computer and run the Conext CL-60 Easy Config Tool.
2. Search for inverters using one of the methods described in the *Conext CL-60 Easy Config Tool Owner's Guide*.
For more information about searching for inverters, see the *Conext CL-60 Easy Config Tool Owner's Guide*.

Step 3: Upgrade the Inverter Firmware

1. In the Easy Config Tool window, click the **Firmware Upgrade** tab.

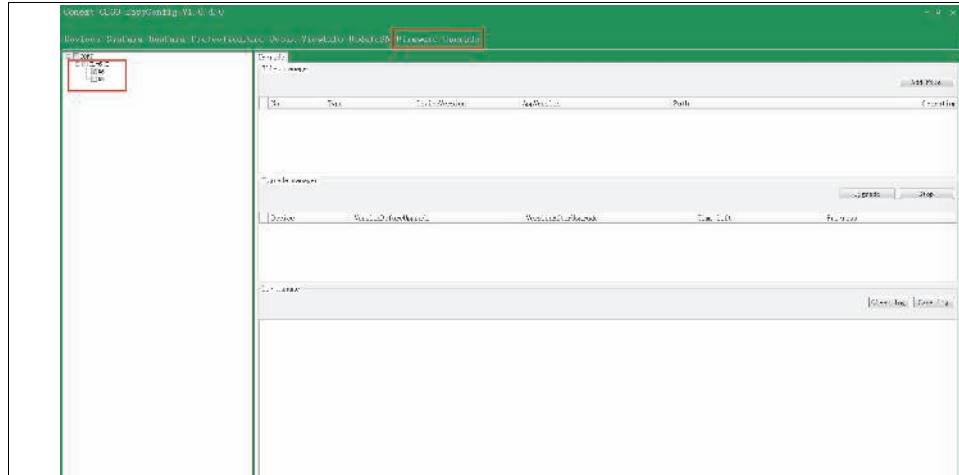

2. In the Device Tree on the left, select the inverters that you want to upgrade the firmware for.
3. In the top right of the Settings window, click the **Add File** button.

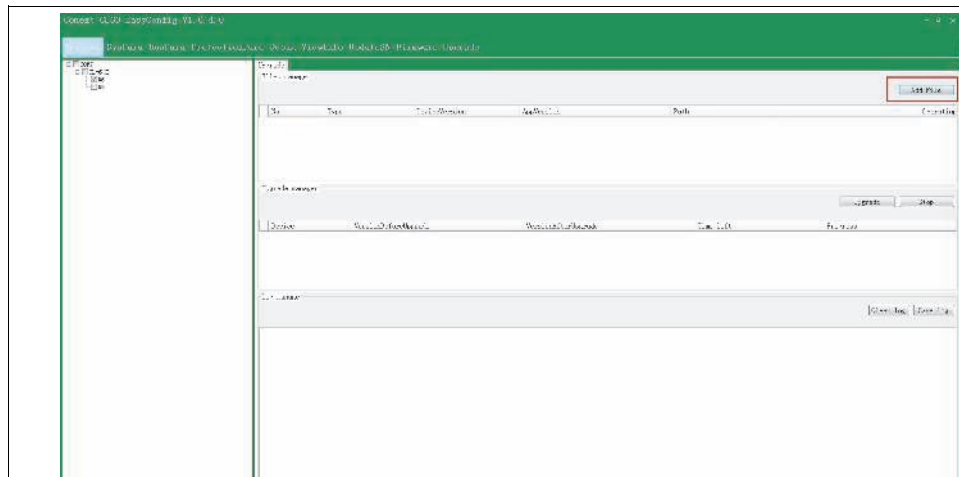

- In the Directory window, navigate to the folder on your computer where the firmware files are stored.

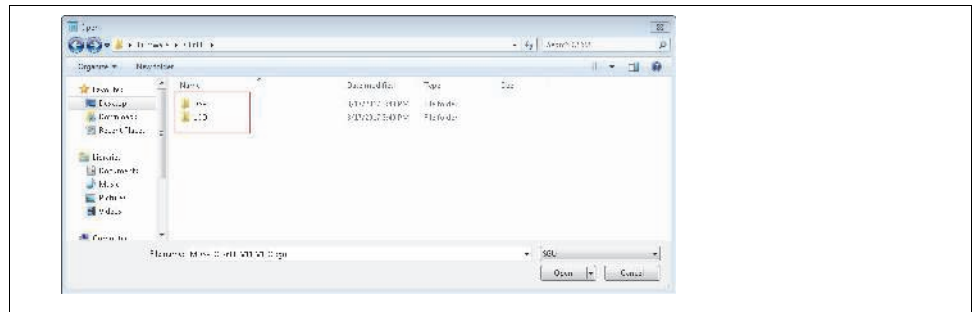

NOTE:

- Make sure you have the correct and latest LCD and DSP firmware files from the website (<http://solar.schneider-electric.com>) and have read the firmware upgrade process associated with the firmware files.
- Use both LCD and DSP firmware files with an **.sgu** extension and select one file at a time for the upgrade.

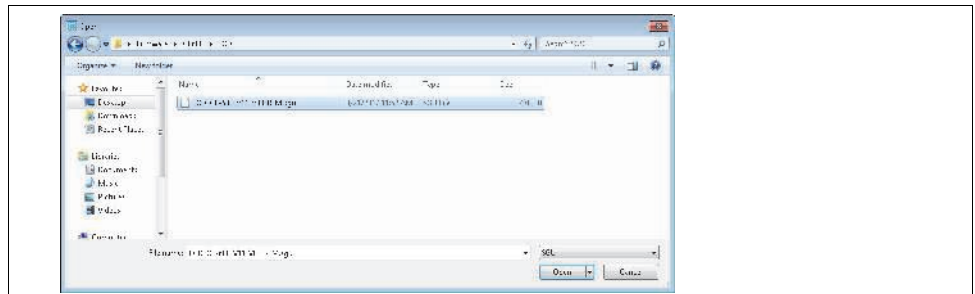

- Select the **LCD firmware** file and insert it in the **Files Manage** view.

NOTE: If you need to delete an incorrect file, click the **Delete** button in the Operating column next to the file.

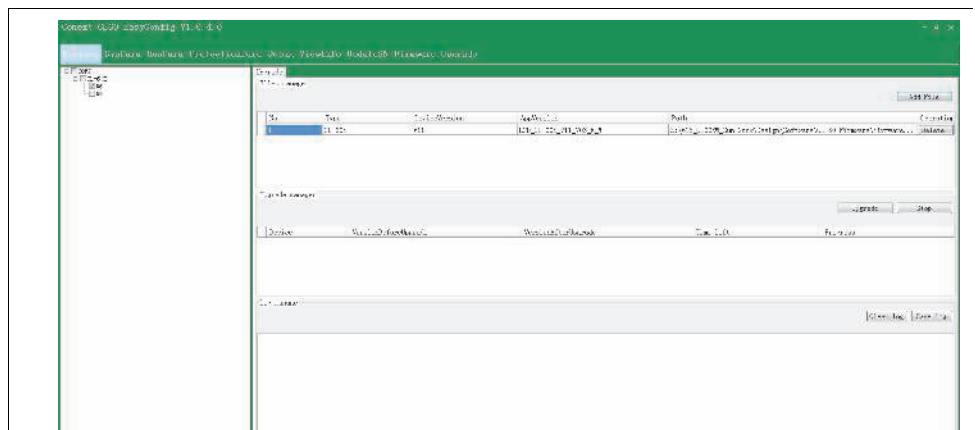

6. Click the **Upgrade** button and monitor the progress of the firmware upgrade. The upgrade should take 5-8 minutes or less. The Upgrade manager section shows the Version before upgrade, Version after upgrade, Time left, and Progress bar for each device being upgraded.

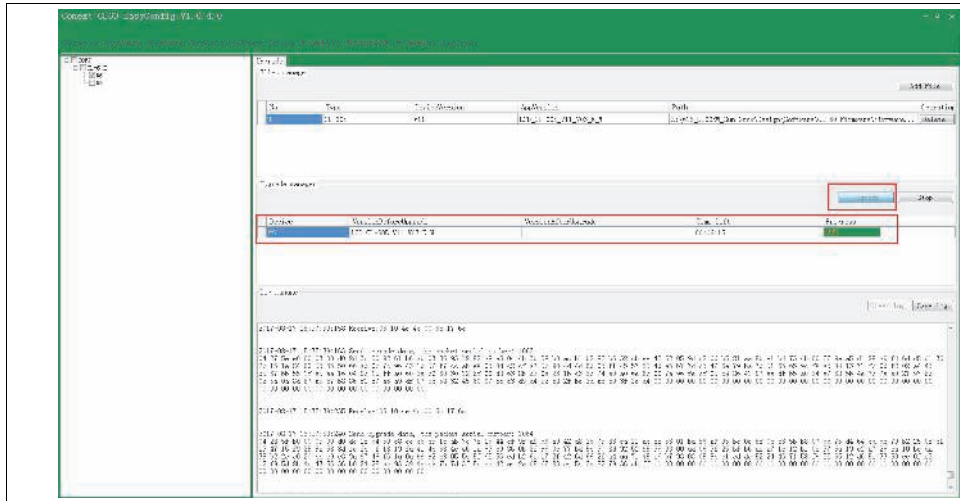

7. Confirm that the firmware upgrade was successful as shown below.
8. Repeat the same steps (5 through 7) for the **DSP firmware** file and monitor the progress of the firmware upgrade. The upgrade should take 5-8 minutes or less. The Upgrade manager section shows the Version before upgrade, Version after upgrade, Time left, and Progress bar for each device being upgraded.
9. Confirm that the firmware upgrade was successful as shown below.

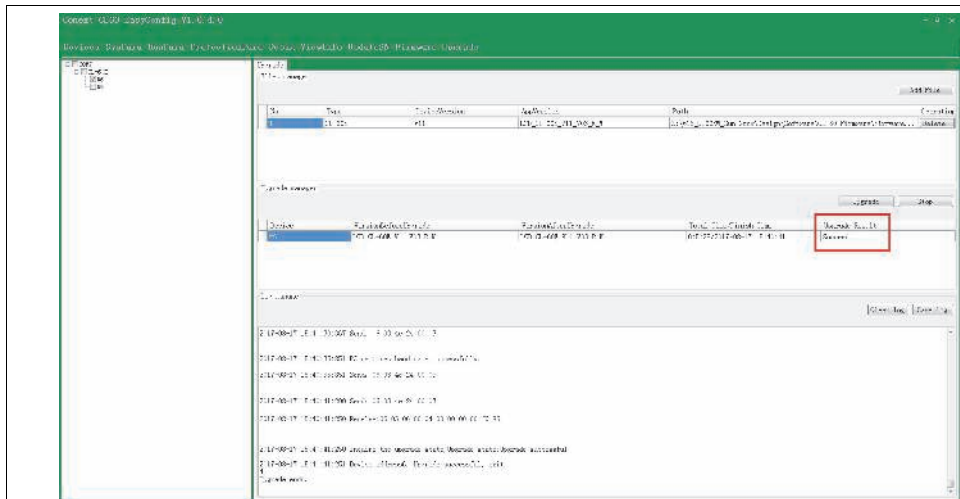

10. Once the firmware upgrade is successful on your CL-60 Inverter(s), disconnect the communication cables and restart the inverter(s).

- 11. On the LCD screen of the inverter(s), verify the firmware version(s).
- 12. Perform any additional settings as required.
If you change any settings, restart the inverter.